

DDC

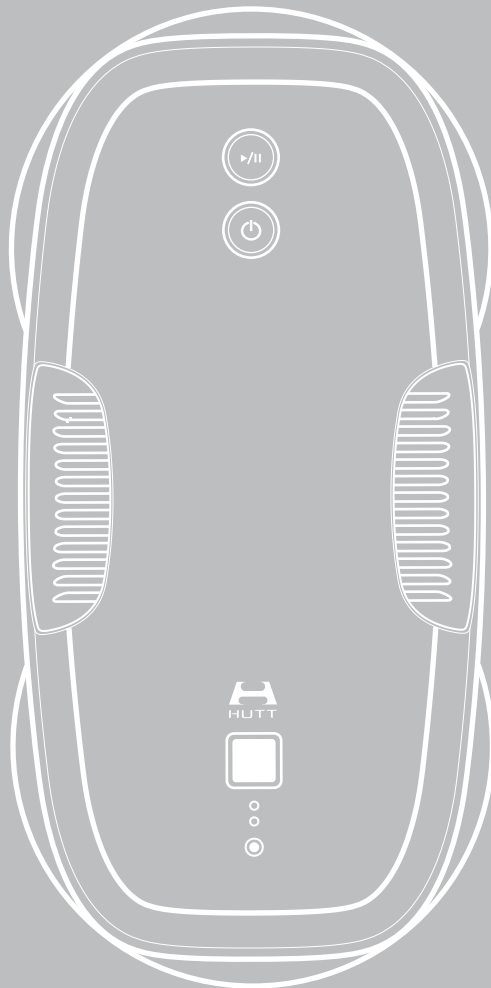

WINDOW CLEANING ROBOT

PRODUCT MANUAL
& WARRANTY CARD



www.huttwisdom.com

Thank you for choosing HUTT window cleaning robot.

//////////
**ease read this manual carefully before use to ensure
our personal safety and the effective use of the product.**

- | | | |
|---------------|--------------------------|------------------|
| 简体中文 (sc) | <input type="checkbox"/> | hrvatski (hr) |
| 繁體中文 (tc) | <input type="checkbox"/> | italiano (it) |
| English (en) | <input type="checkbox"/> | lietuvių (lt) |
| 日本語 (jp) | <input type="checkbox"/> | latviešu (lv) |
| 한국어 (kr) | <input type="checkbox"/> | magyar (hu) |
| русский (ru) | <input type="checkbox"/> | Malti (mt) |
| español (es) | <input type="checkbox"/> | Nederlands (nl) |
| čeština (cs) | <input type="checkbox"/> | polski (pl) |
| dansk (da) | <input type="checkbox"/> | português (pt) |
| Deutsch (de) | <input type="checkbox"/> | română (ro) |
| eesti (et) | <input type="checkbox"/> | slovenčina (sk) |
| ελληνικά (el) | <input type="checkbox"/> | slovenščina (sl) |
| français (fr) | <input type="checkbox"/> | suomi (fi) |
| Gaeilge (ga) | <input type="checkbox"/> | svenska (sv) |



Contents

01 Product profile

02 Accessories List

03 Installation Instructions

05 Instructions & precautions

06 Path Planning Instructions

07 LED Indicators/sound & their meanings

08 Remote Control Instructions

09 Basic Parameters

09 Troubleshooting

10 Safety issues

Product profile

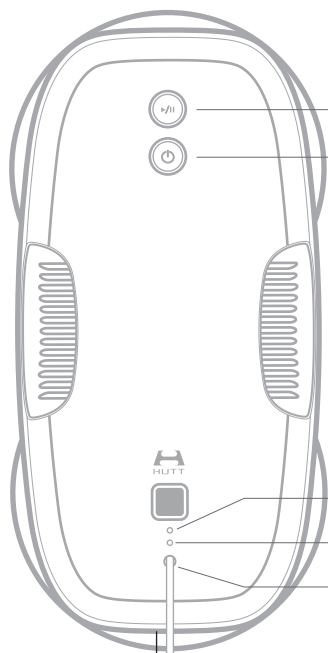

Start/Stop

Power On/Off

Press and hold for 3 seconds to power on or off.

Charge indicator

Status indicator

Power Cord

Side view

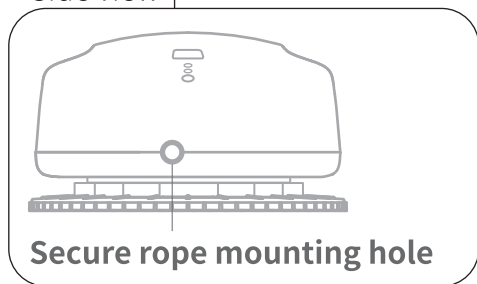

Secure rope mounting hole

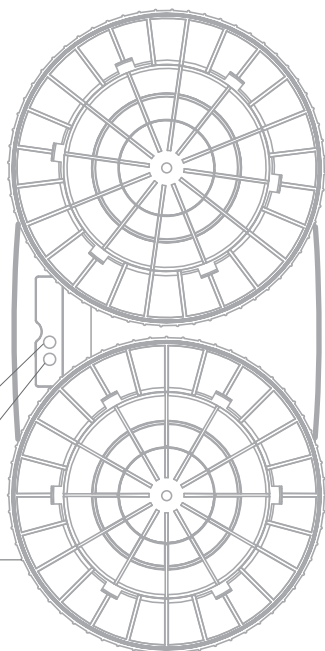

Status indicator (green)

Status indicator (red)

Detachable turning disc

Under normal conditions, do not detach, but directly put on the cleaning cloth.

Parts List

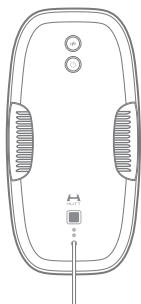

Main machine and extension cord

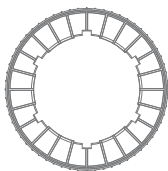

Turning disc (Installed)



Remote control

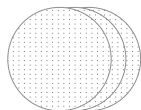

Cleaning cloth

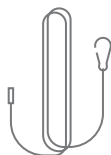

Secure rope

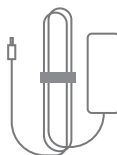

Adapter

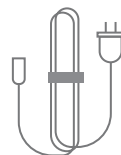

Plug



Sprinkling can



User's manual

Installation Instructions

Make sure that the fastening end of the secure rope is tightened on the machine.

When using, it is recommended to fix the locking ring on a solid object that can not be dragged, with an appropriate length of the rope to allow the machine to work.

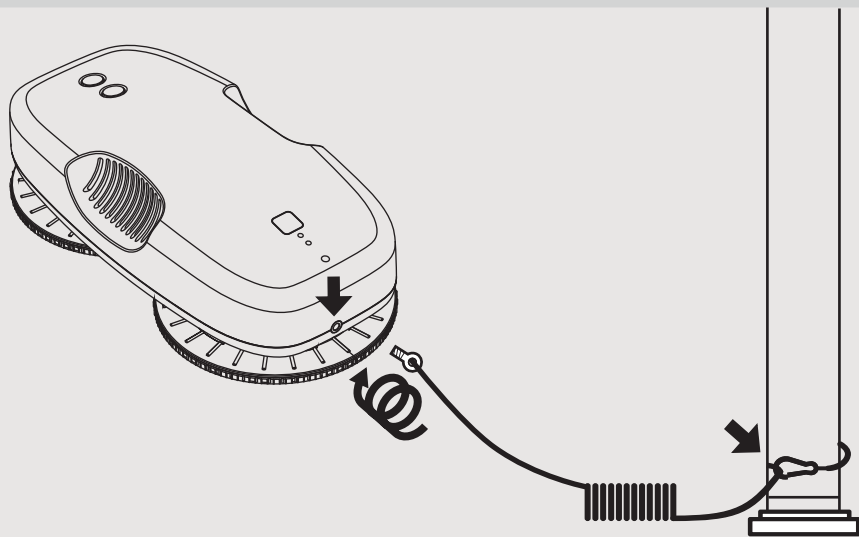

Wet the cleaning cloth and wring it out until it doesn't drip. Put it on the turning disc.

If there is much sand attached to the pane, use dry cleaning cloth first, instead.

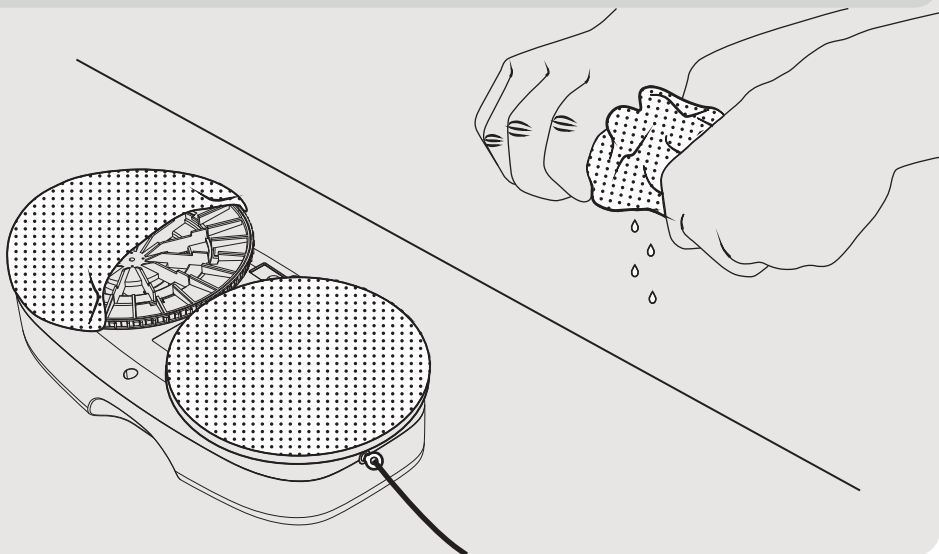

Once the turning disc is removed, make sure it is installed back in place before use.
After the cleaning ring is installed, please check whether it is 360° even with the machine to ensure that each locking buckle is in place to avoid air leakage.

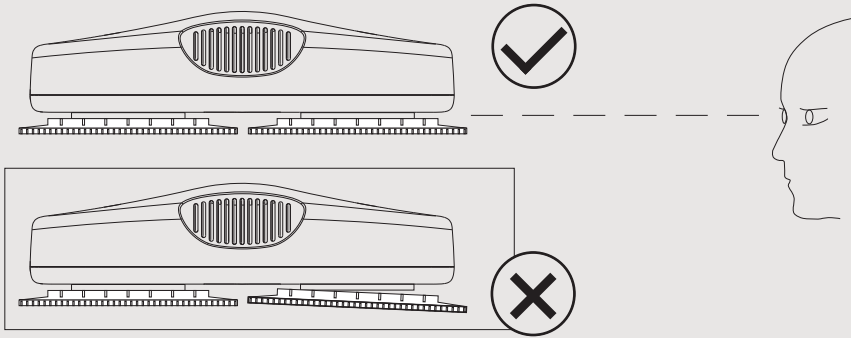

Lock the knob of the extension cable and the cable of adapter. Connect the plug to the adapter, and then connect the socket to the power supply.

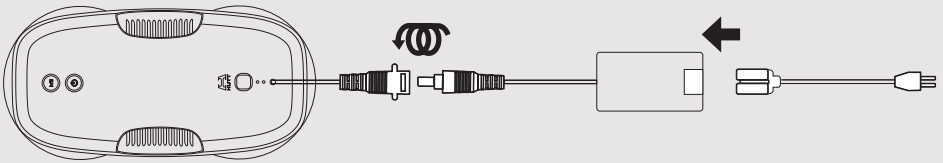

Press and hold Power on for 3 seconds. Place the machine on the pane. Press Start to work.

Don't place the machine too close to window frame. Check air-tightness of the locking buckles of the turning disc in case of failure in sucking to attach to the window pane.

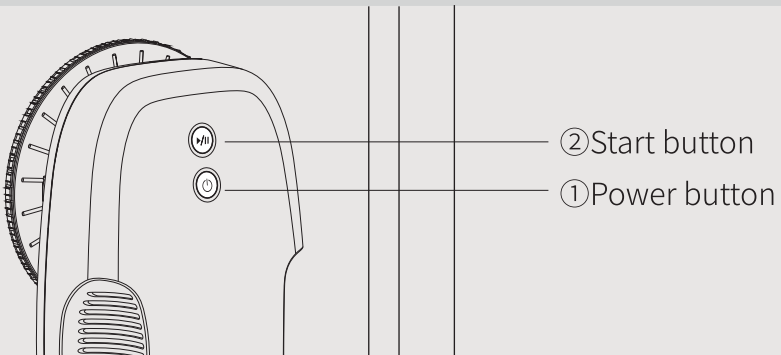

Instructions & precautions



Secure rope

Check whether there is any damage of the secure rope and whether the secure rope is securely fastened to the fixing object.



Work environment inspection

Ensure that the pane is dry. Do not use it in rainy days or when the pane is wet and foggy.

Do not use it on broken or cracked glass.

If operated on the external side of window pane at height, safety warning must be set on the ground beneath to prevent accidental personal injury.



Dry clean and wet wipe

If there is a lot of sand and dust on the pane, please use a dry cleaning cloth first; Common dirty can be directly wiped with cleaning cloth by first wetting it and then wringing it dry before installation;

In case of skidding when climbing, please install a dry cloth moist with 2~3 sprays of clean water with a spray can;

In case of presence of stubborn stains in a small area, wipe it repeatedly by operating the machine with the remote control.



Start-up

① Make sure the power cord and plug are connected.

② Press and hold the power button (3 seconds) to start the machine, and make sure that the fan rotates and put the machine far enough away from the window frame.

③ Make sure the machine is attached to the pane before release it.

④ Press the start button to activate the movement of the machine.



Remove the machine

① When the machine is still in running, hold the secure rope with one hand, and hold the machine with the other hand by pressing and holding the power button to remove it.

② If your hand can't touch the machine and there is no remote control, please pull the safety rope close to the glass, slowly pull the machine back to the position that the hand can reach, and then remove the machine.



Power failure protection

In case of accidental power failure, the machine will use the internal battery power supply to maintain the machine suction for 20 minutes, with accompanied alert by warning sound and light. Please remove the machine as soon as possible.

Path Planning Instructions

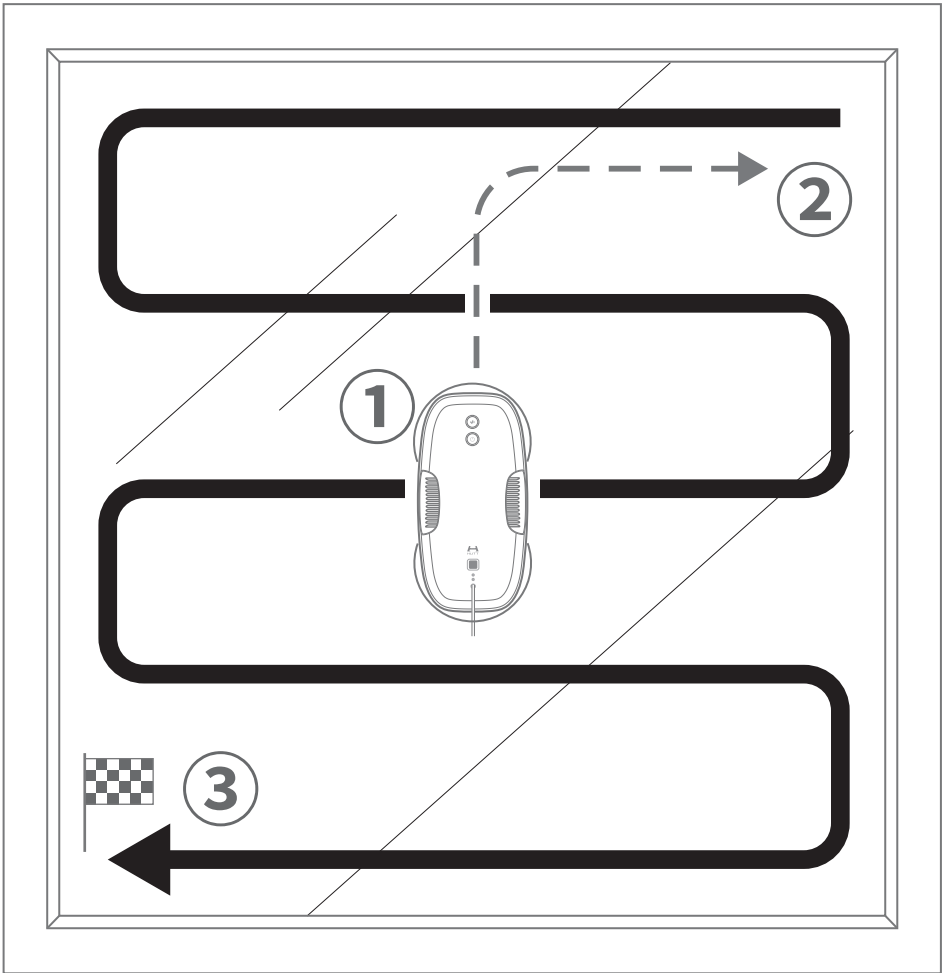

Automatic path planning for window cleaning

- ① Place the machine at the center of the window pane and far enough away from the window frame, press the start button, the machine will automatically move up, then move to the right, and finally reach the upper right corner of the window pane.
- ② When the machine reaches the upper right corner, it wipes the windows from top to bottom following an S-shaped path.
- ③ Depending on the shape of the window pane, the machine will use the bottom left or right corner of the pane as the end point of the wipe.
- ④ After the cleaning is finished, the machine will automatically move to the position near the point of origin, convenient for being removed by the operator.

LED indicators and their meanings

Charging Indicator

Status indicator

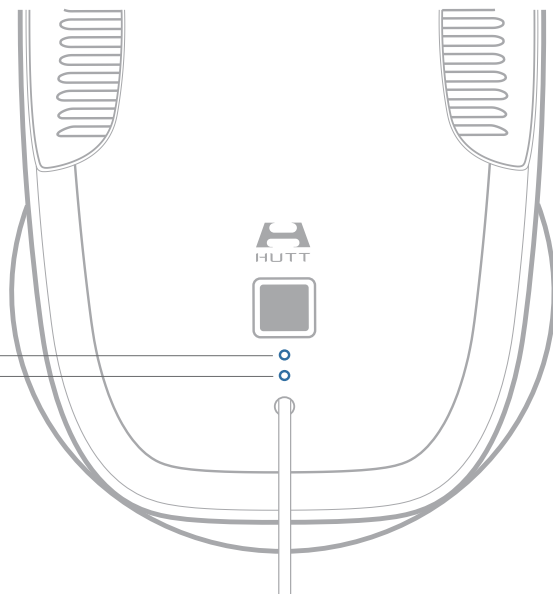

LED / Sound	Status	Meaning
Status indicator	Constantly green	The working condition is normal.
	Constant green + 3 long beeps	Cleaning work is completed.
Charge indicator	Constant red	The power of the built-in battery is insufficient. Please charge it for 15 minutes before power on
	Blinking blue	Built-in battery charging, please continue the charging if it turns red when pressed Start.
	Constant blue	The built-in battery is fully charged.
Charge indicator	Blinking red	The machine is powered off, please connect the power supply or remove the machine; Insufficient suction, please check the machine for any air leakage; If it is due to either too poor or too strong friction between the window pane and the machine, replace the cleaning cloth where necessary.
Status indicator	The red and the blue are lit alternatively	Machine abnormal, please contact the customer service

Remote control instructions

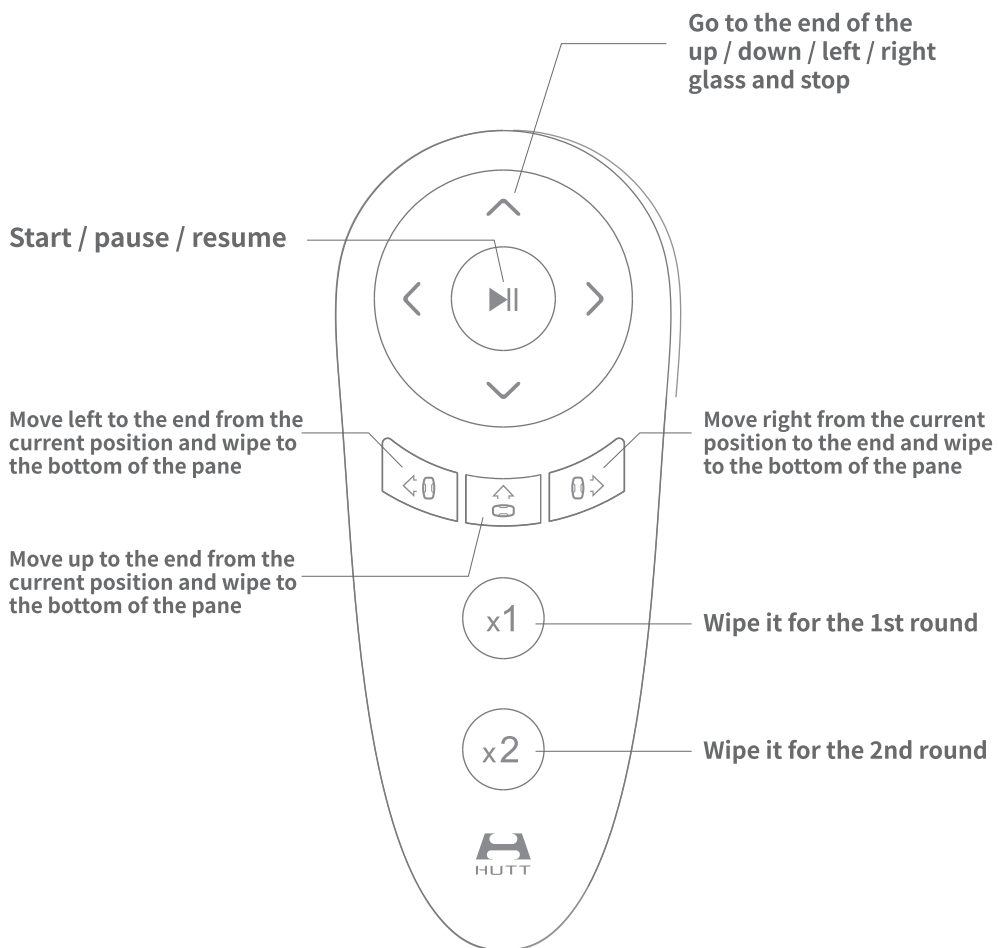



In order to avoid misoperation by children, it is necessary to press Pause between each two commands

Basic Parameters

Model No	DDC5/DDC55
Rated voltage	24V
Rated power	90W
Noice Decibel	≈65db
Size	290*135*85cm
Charging current	300mA
Battery capacity for power cut protection	650mAh
Power failure protection suction-maintaining time	At least 20min <small>(The charge of the built-in battery will affect the adsorption time)</small>
Variable frequency suction range	2000~3800Pa
Minimum area required for use	300*300mm

Troubleshooting

- ① When the fault light is blinking red with continuous short "beep" sound, please check:
 - Whether the power cord plug is loose or damaged, resulting in power failure or poor contact.
 - Whether the window pane or the cleaning cloth is too wet, resulting in too low friction force.
 - Excessive friction of the cleaning cloth caused by sticky matters on the pane.
 - Whether the cleaning ring is installed in place without air leakage.
 - Whether the machine surface is uneven, causing air leakage.
 - Whether the suction inlet is blocked
- ② The red and green fault light blinking alternately with warning sound indicates that the machine is working abnormally. Please contact the customer service directly.
- ③ In case that the machine fails to detect the upper edge of the window during its upward climbing due to skidding, please press the pause button and use the buttons   on the remote control to operate the machine to continue cleaning from the current position to the left / right.
- ④ In case that the machine fails to move smoothly, please change the cleaning cloth, or check whether the screw of the cleaning wheel is loose.
- ⑤ Press the pause button to remove the machine if it fails to stop moving automatically when the cleaning of the whole window pane has been completed.



Requirements:

- ① Be sure to check whether the safety rope is damaged, and use the safety rope to fix the machine for use. Warning shall be set on the ground for aerial work.
- ② This product should not be drenched with water.
- ③ Do not use it on cracked and damaged glass.
- ④ When cleaning the outer surface of the machine, the machine must be shut down to avoid danger during the movement of the machine.
- ⑤ Do not let your fingers or any body parts close to the rotation and opening of this product.
- ⑥ Please use this product according to the instructions. Please contact customer service when the fault cannot be eliminated. Do not repair it without permission to avoid danger.
- ⑦ It is only used for cleaning the household environment with 0°~40°



Battery and Charging

- ① Do not use a third-party charger or disassemble and refit the main engine, battery and charger without permission.
- ② If the charger is damaged or broken, please do not continue to use it. Please contact customer service.
- ③ Put the charger away from the heat source.
- ④ If the product needs to be transported, it is recommended to use the original package for transportation and shut down the machine.
- ⑤ If you do not use this product for a long time, please fully charge and turn off the machine and place it in a cool and dry place. Charge it at least once every 3 months to avoid battery failure caused by overdischarge of the battery.



Manufacturer address Beijing Hutt Wisdom Technology Co.,LTD
No. 432, 4th Floor, Building 12, No. 8,
XinjiekouWai Street, Xicheng District, Beijing city

Customer Service Hotline +0086 400-160-8988

Business Cooperation biz@huttwisdom.com

Official Website www.huttwisdom.com